

PLACE THOSE PARTS BELOW  
3RD DIMM FOR TERMINATION

JET WAY INFORMATION		
Title	<b>DIMM3</b>	
Size	Document Number	Rev
B	<b>1405</b>	<b>3.0</b>
Date:	Thursday, October 18, 2001	Sheet 5 of 15

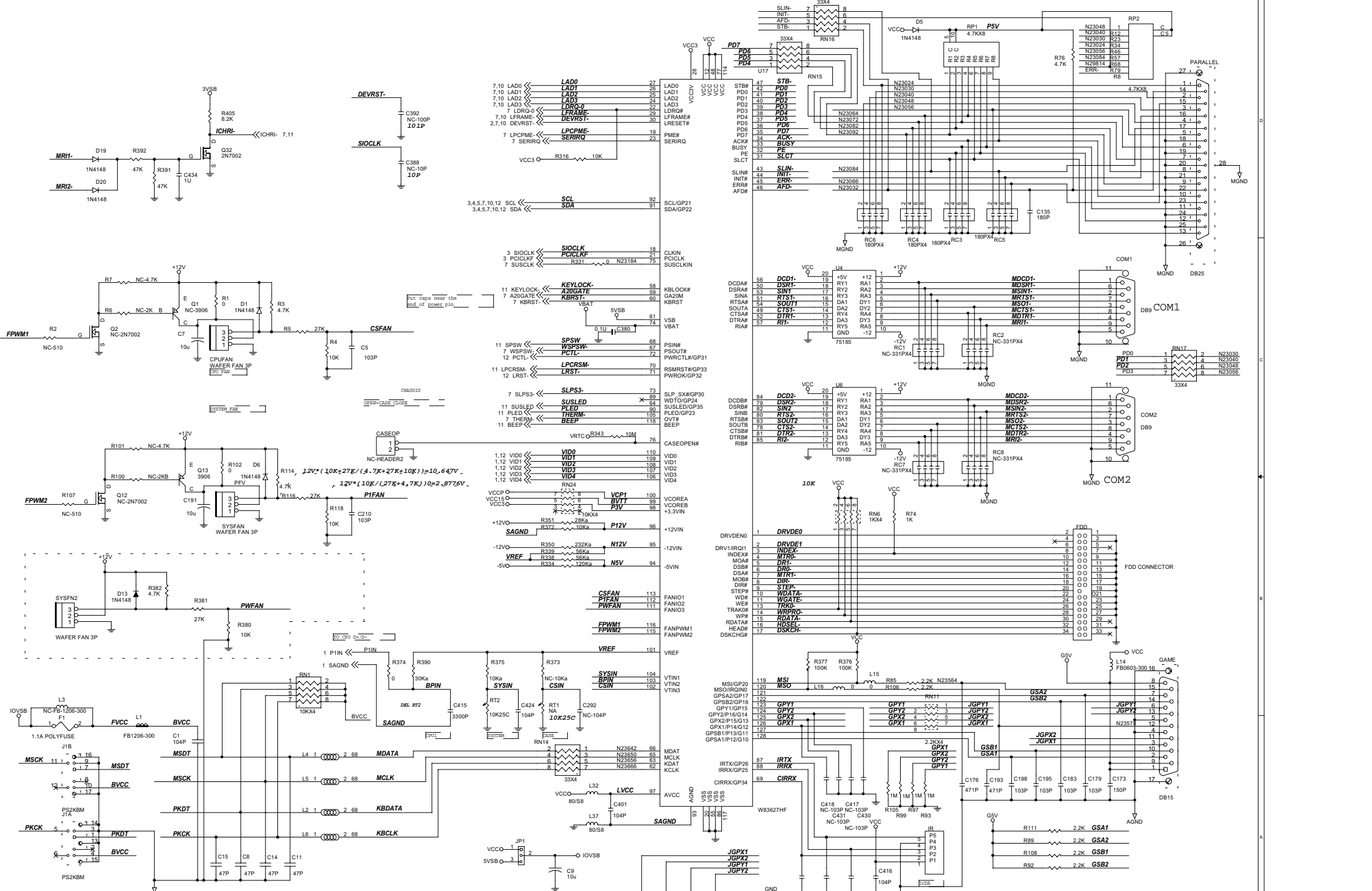





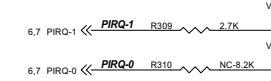
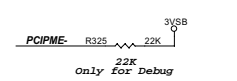
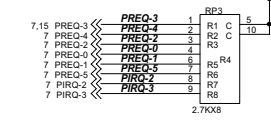
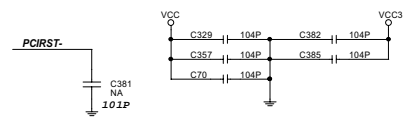
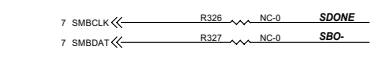
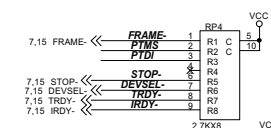
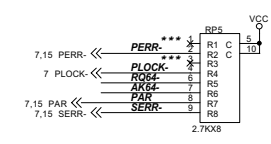
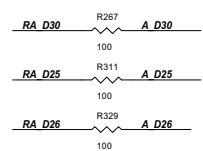
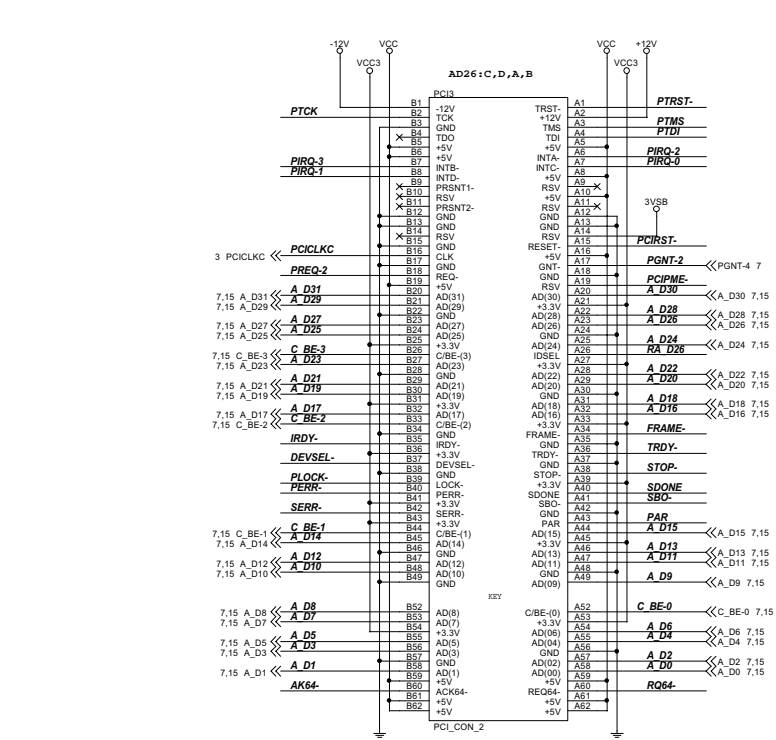
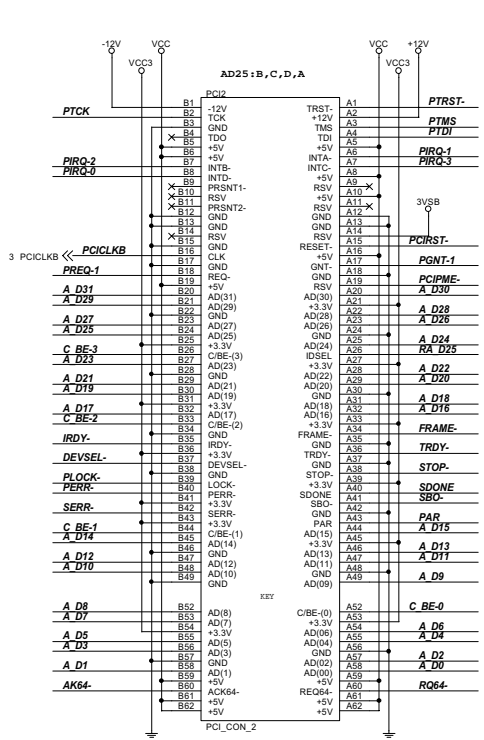
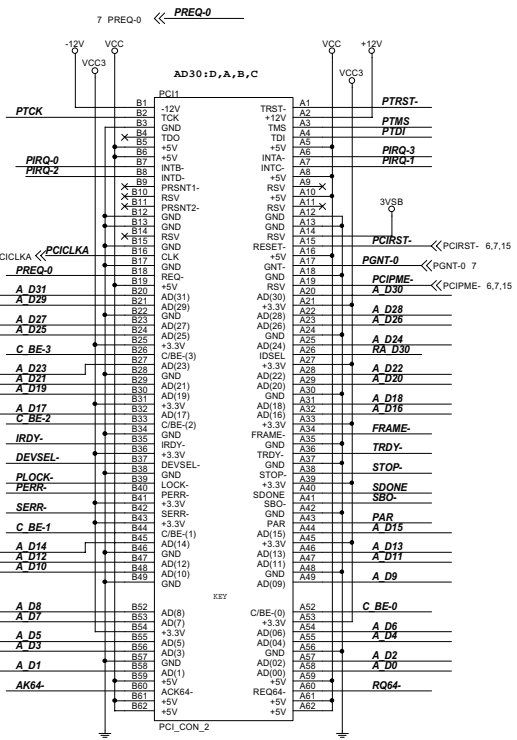





VID4	VID3	VID2	VID1	VID0	VCRDR
1	1	1	1	1	1.100
1	1	1	1	0	1.125
1	1	1	0	1	1.150
1	1	1	0	0	1.175
1	1	0	1	1	1.200
1	1	0	1	0	1.225
1	1	0	0	1	1.250
1	1	0	0	0	1.275
1	0	1	1	1	1.300
1	0	1	1	0	1.325
1	0	1	0	1	1.350
1	0	1	0	0	1.375
1	0	0	1	1	1.400
1	0	0	1	0	1.425
1	0	0	0	1	1.450
1	0	0	0	0	1.475
0	1	1	1	1	1.500
0	1	1	1	0	1.525
0	1	1	0	1	1.550
0	1	1	0	0	1.575
0	1	0	1	1	1.600
0	1	0	1	0	1.625
0	1	0	0	1	1.650
0	1	0	0	0	1.675
0	0	1	1	1	1.700
0	0	1	1	0	1.725
0	0	1	0	1	1.750
0	0	1	0	0	1.775
0	0	0	1	1	1.800
0	0	0	1	0	1.825
0	0	0	0	1	1.850

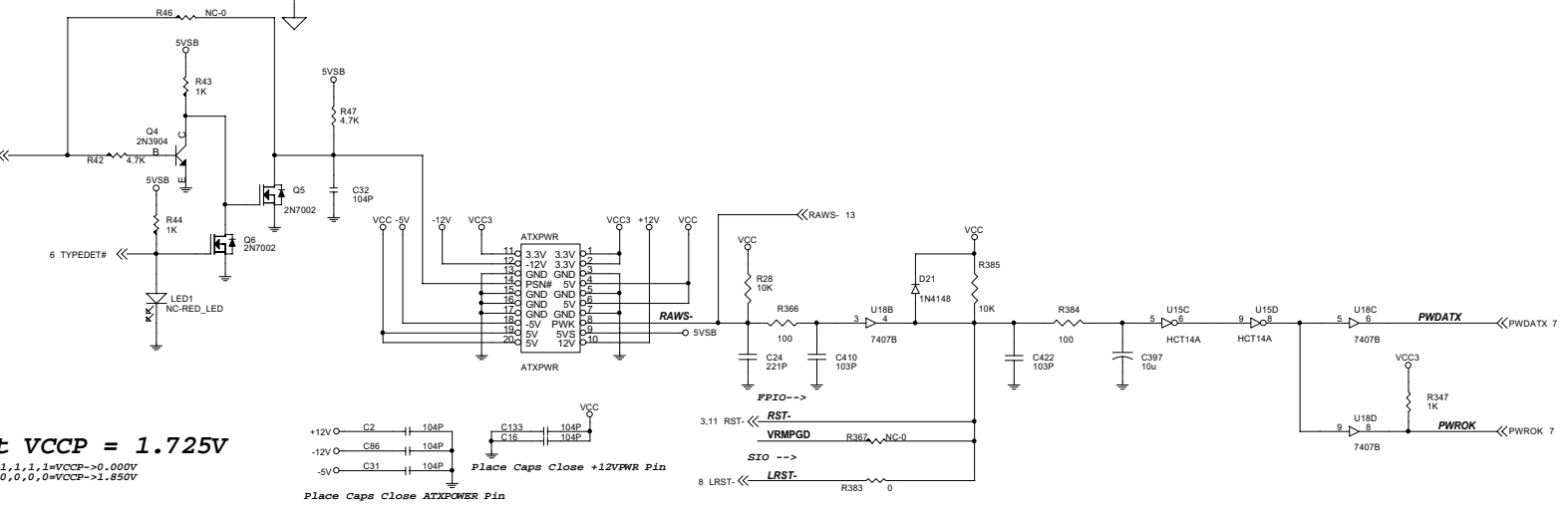
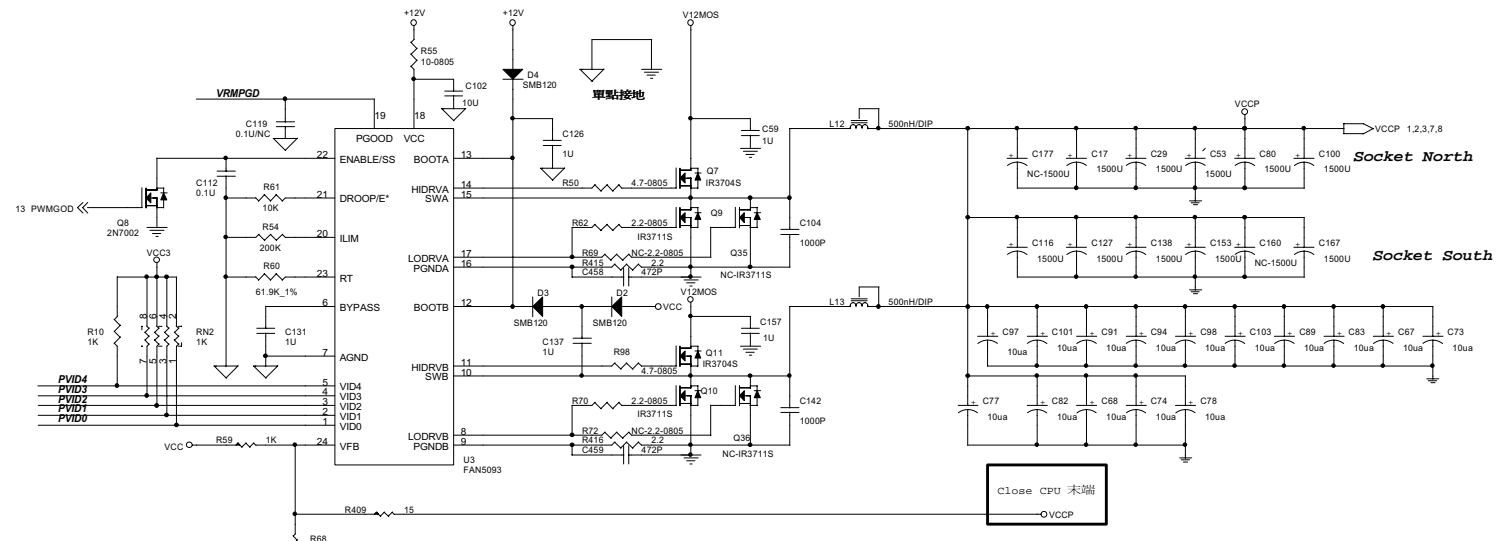

**Default VCCP = 1.725V**

VID[4..0]=1,1,1,1,VCCP->0.000V  
 VID[4..0]=0,0,0,0,VCCP->1.850V

+12V C2 104P  
 -12V C86 104P  
 -5V C31 104P  
 Place Caps Close +12VWR Pin

VCC C133 104P  
 VCC C16 104P  
 Place Caps Close ATXPOWER Pin

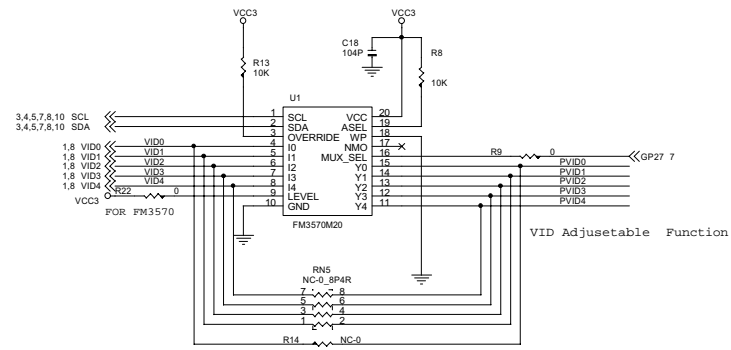

TO PWM  
 REGULATOR  
 and I/O  
 WHM

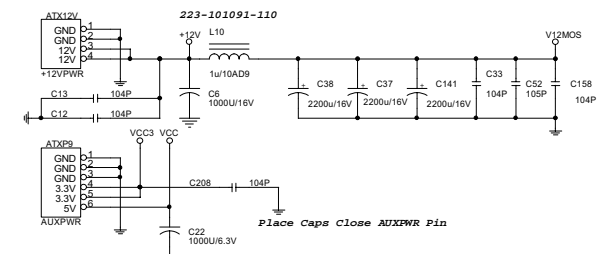

**12VATXPOWER SPEC. Ver. 1.0**

JET WAY INFORMATION		
Title	FAN5093/ATX12V	
Size	Document Number	1405
C	Date	Thursday, October 18, 2001
	Sheet	12 of 15
	Rev	3.0

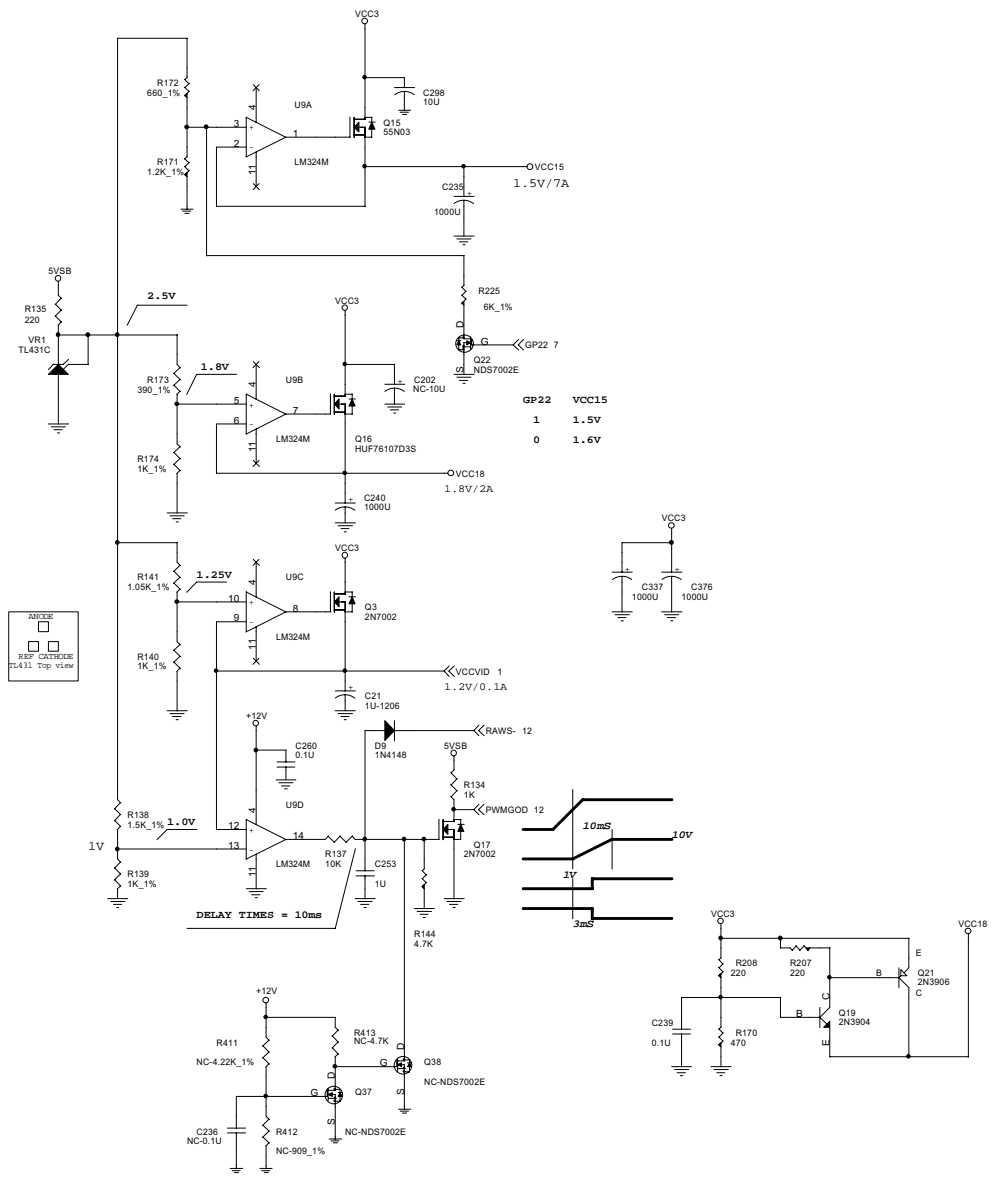

GP22

VCC15	1	1.5V
VCC18	0	1.6V

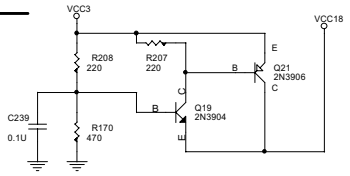
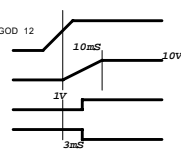
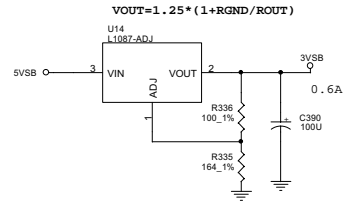
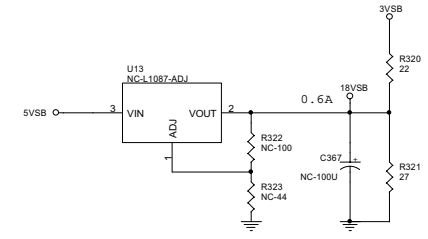
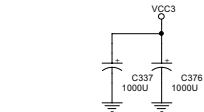

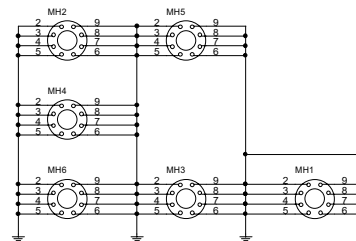
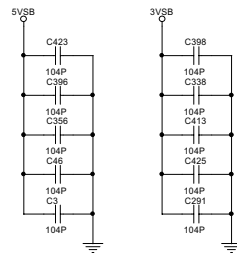
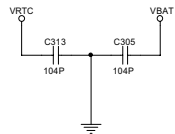
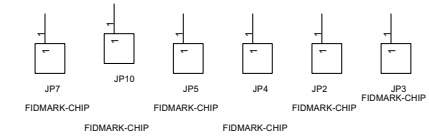
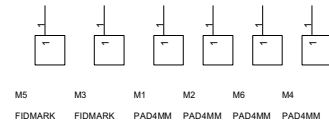
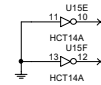
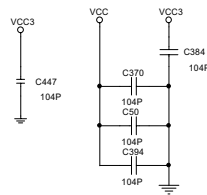
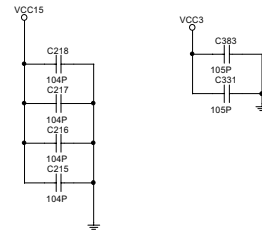
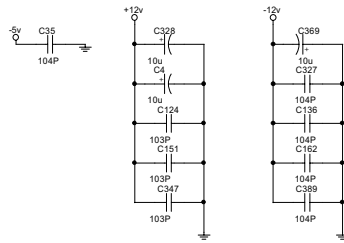
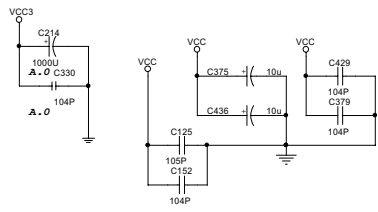

JET WAY INFORMATION			
Title	MISC		
Size	Document Number	1405	Rev 3.0
Date	Thursday, October 18, 2001	Sheet	14 of 15

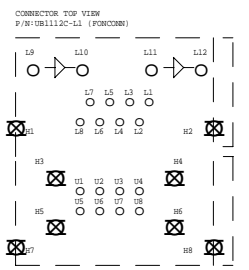
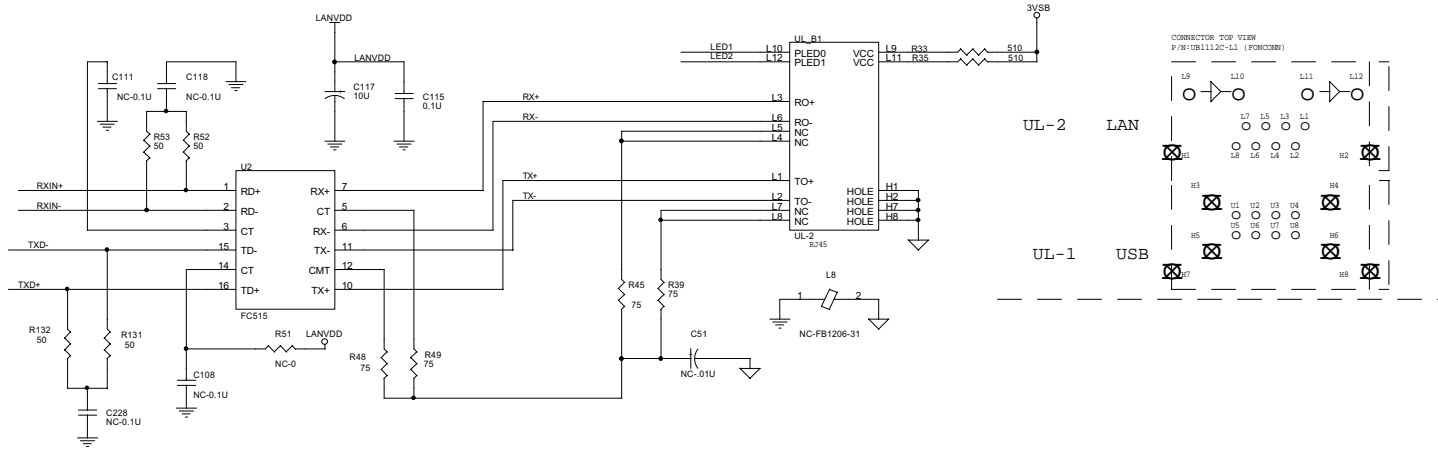
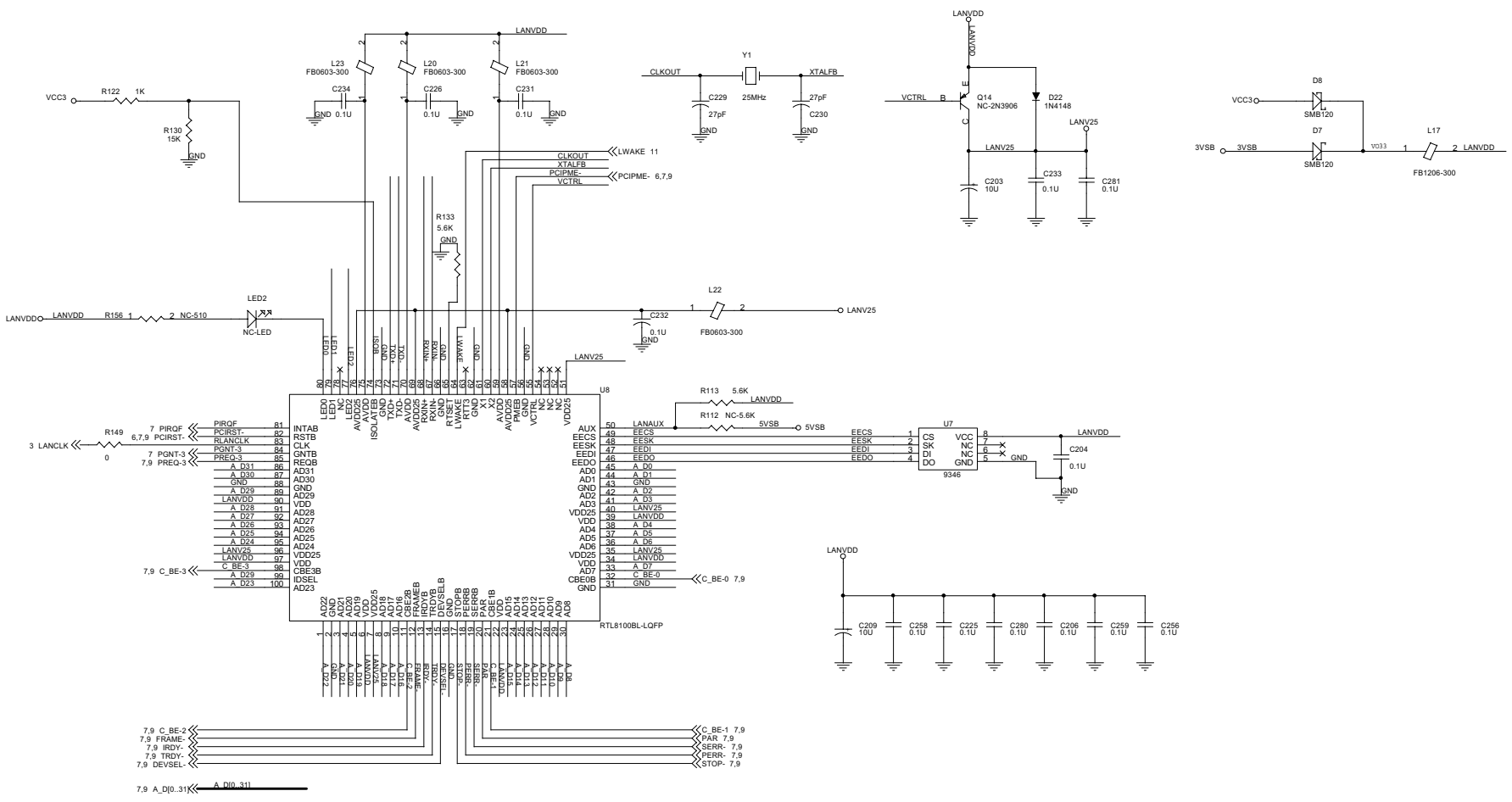

JET WAY INFORMATION			
Title	RTL8100B(L)		
Size	Document Number	1405	Rev 3.0
Custom			
Date:	Thursday, October 18, 2001	Sheet	15 of 15